

ASSEMBLY INSTRUCTIONS
INSTRUCTIONS DE MONTAGE
INSTRUCCIONES DE MONTAJE

MODEL/ MODÈLE/ MODELO: T4115-07 OVAL END TABLE







CAUTION: PLEASE READ ALL INSTRUCTIONS BEFORE STARTING THE ASSEMBLY OF THIS PRODUCT. THESE PIECES ARE HEAVY. IN ORDER TO PREVENT PERSONAL INJURY AND ENSURE THAT THIS PRODUCT IS NOT DAMAGED DURING THE ASSEMBLY PROCESS, IT IS STRONGLY RECOMMENDED TO ENLIST THE ASSISTANCE OF ONE OR MORE PERSONS. IN CASE OF EXCESS STAIN, WIPE THE BOTTOM OF THE UNIT BEFORE PLACING ON ANY SURFACE.

ATTENTION: VEUILLEZ LIRE TOUTES LES INSTRUCTIONS AVANT DE COMMENCER L'ASSEMBLAGE DE CE PRODUIT. LES PIECES SONT LOURDES. POUR EVITER TOUTE BLESSURE ET POUR VOUS ASSURER QUE LE PRODUIT N'EST PAS ENDOMMAGE' PENDANT L'ASSEMBLAGE, NOUS VOUS RECOMMANDONS DE FAIRE APPEL A UNE OU PLUSIEURS AUTRES PERSONNES. EN CAS DE TACHE EXCESSIVE, ESSUYEZ LE FOND DE L'UNITE' AVANT LE PLACEMENT SUR N'IMPORTE QUELLE SURFACE.



CUIDADO: FAVOR DE LEER TODAS LAS INSTRUCCIONES ANTES DE ENSAMBLAR SU PRODUCTO, ESTAS. PIEZAS SON PESADAS. PARA PREVENIR HERIDAS PERSONALES Y ASEGURAR QUE SU PRODUCTO NO SEA DAN ADO MIENTRAS ES ENSAMBLADO. SE RECOMIENDA LA ASISTENCIA DE UNA O MAUS PERSONAS.

WARNING: PROTECTIVE GLIDE IS PLACED UNDER EACH LEG OF THE FURNITURE TO RESIST SCRATCHES ON FLOOR SURFACE. SOME FLOOR SURFACES CAN BE EXTRA SENSITIVE TO SCRATCHES AND MARKINGS, IF YOU ARE NOT SURE CONSULT WITH YOUR DEALER. AVERTISSEMENT. LES PIEDS DES MEUBLES SONT MUNIS DE PATINS DESTINES A PROTEGER LE PLANCHER. CERTAINS REVETEMENTS DE SOL PEUVENT ETRE TRES FRAGILES. EN CAS DE DOUTE. CONSULTER LE MARCHAND.

LIST OF PARTS AND HARDWARE/ LISTE DES PIÈCES ET DU MATÉRIEL/ LISTA DE PIEZAS Y HARDWARE

NO#/ NOMBRE/ NÚMERO	DESCRIPTION/ DESCRIPTION/ DESCRIPCIÓN	QUANTITY/ QUANTITÉ/ CANTIDAD
A	BOLT/ BOULON/ TORNILLO 1/4" x 1-3/4"L 	8 PCS
B	BOLT/ BOULON/ TORNILLO 1/4" x 5/8"L 	4 PCS
C	BOLT/ BOULON/ TORNILLO 1/4" x 1/2"L 	4 PCS
D	LOCK WASHER/ RONDELLE DE BLOCAGE/ARANDELA DE BLOQUEO 1/4" 	12 PCS
E	FLAT WASHER/ RONDELLE PLATE/ ARANDELA PLANA 1/4" 	12 PCS
F	ALLEN KEY/ CLÉ ALLEN/ LLAVE INGLESA ALLEN 6 1/4" 	1 PC
G	"L" BRACKET / ÉQUERRE EN L/ SOPORTE EN FORMA DE L 	4 PCS

LIST OF PARTS AND HARDWARE/ LISTE DES PIÈCES ET DU MATÉRIEL/ LISTA DE PIEZAS Y HARDWARE

NO#/ NOMBRE/ NÚMERO	DESCRIPTION/ DESCRIPTION/ DESCRIPCIÓN	QUANTITY/ QUANTITÉ/ CANTIDAD
1	TABLE TOP/ DESSUS DE LA TABLE/ PARTE SUPERIOR DE LA MESA 	1 PC
2	LEG / JAMBE / PIERNA 	4 PCS
3	BOTTOM PANEL/ PANNEAU DU BAS/ PANEL INFERIOR 	1 PC

NOTE:
 ASSEMBLE UNIT ON A SOFT SURFACE.
 ASSEMBLEZ L'UNITÉ SUR UNE SURFACE MOLLE.
 ENSAMBLE LA UNIDAD EN UNA SUPERFICIE PLANA Y SUAVE.

DO NOT TIGHTEN BOLTS UNTIL ALL PARTS AND HARDWARE OF THE UNIT ARE ASSEMBLED.
 NE SERREZ PAS LES BOULONS JUSQU'À CE QUE L'UNITÉ SOIT COMPLÈTEMENT ASSEMBLÉE.
 NO APRIETE LOS TORNILLOS HASTA QUE LA UNIDAD ESTE COMPLETAMENTE ENSAMBLADA.



WARNING:
 ONLY USE THE HAND TOOLS PROVIDED

MODEL/ MODÈLE/ MODELO: T4115-07 OVAL END TABLE

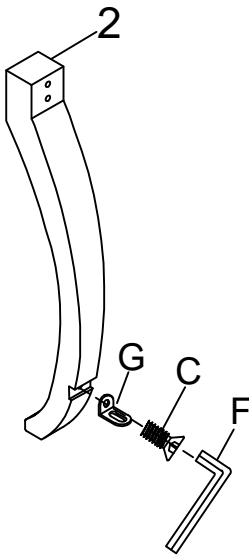

Step/ Étape/ Paso 1

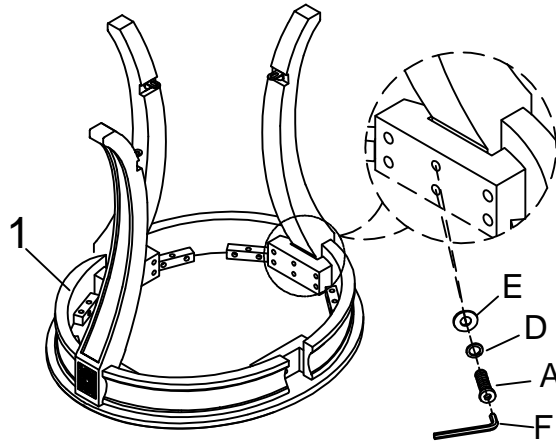

Step/ Étape/ Paso 2

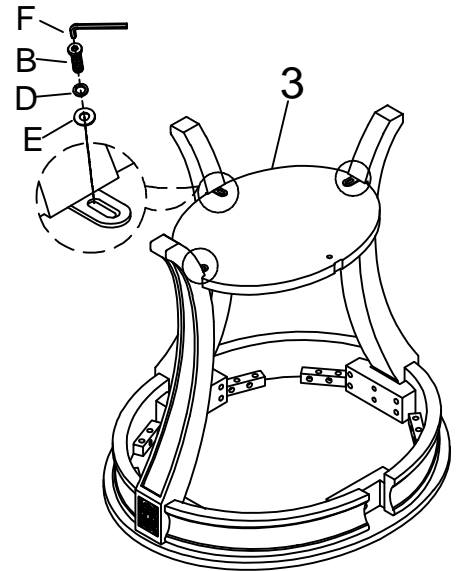

Step/ Étape/ Paso 3

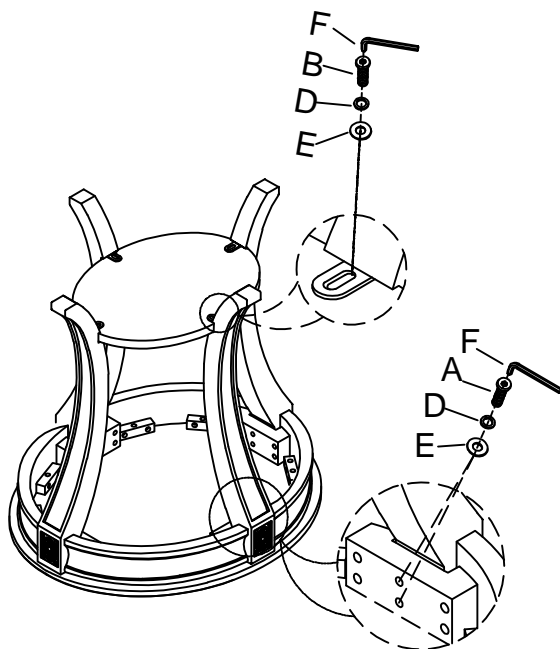

Step/ Étape/ Paso 4

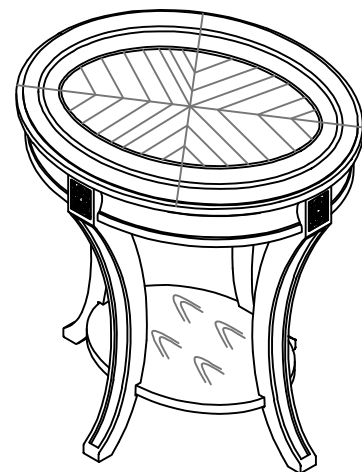

NOTE:
SPIRIT LEVELER NOT INCLUDED BUT NEEDED TO EVEN THE FLOOR.
SPIRIT LEVELER NON INCLUS MAIS NÉCESSAIRE MÊME LE SOL.
NIVELADOR DE ESPÍRITU NO INCLUIDO PERO ES NECESARIO PARA INCLUSO EL PISO.



WARNING:
ONLY USE THE HAND
TOOLS PROVIDED