





Assembly instructions for Chest 591-130



Caution: Please read instructions thoroughly before unpacking assembly parts. Sharp, exposed staple tips can cause injury, therefore, for your protection, please remove any exposed staples used in packing.

1. We recommend that you should assemble this product with the assistance of another person; this will make assembly easier, and will help to eliminate damage to the product or injury to persons during assembly.
2. Be sure to check all packing materials carefully for small parts that may have come loose inside the carton during shipment.
3. Please do not over tighten screws or bolts.
4. Please put all parts on a non-abrasive floor before assembly, and follow the assembly steps to assemble your newly purchased product correctly and efficiently.
 - Do not allow children to climb on furniture.
 - Do not place television sets on top of chests, door chests and/or dressers.
 - Please place heaviest objects in the lowest drawers.
 - Please have no more than one drawer open at a time.

⚠ WARNING: To avoid serious personal injury:

- Carefully and strictly follow assembly instructions. Improper assembly of furniture can result in structural failure, instability of the product, or tip-over.
- Monitor and carefully control the assembly components. These include small parts and hardware that may present a choking hazard to small children. This furniture should be assembled only by responsible adults and children should not be involved in the assembly process.
- Where provided, wall mounting hardware should always be used as prescribed in these instructions to anchor furniture to walls. Proper use of the wall mounting hardware can significantly reduce the potential for furniture tip-over and crushing injuries.

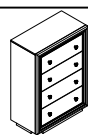
NO.:	HARDWARE LIST (591-130)		Q'TY
1		TIPPING RESTRAINT KIT	1 set
2		(L57x4MM) ALLEN KEY	1 piece
3		(Ø5/16*18*2-1/2"L) BOLT	8 pieces
		(Ø5/16*13*1.2MM) SPRING WASHER	8 pieces
		(Ø5/16*19*1.8MM) FLAT WASHER	8 pieces

NO.:	PARTS LIST		
A		Chest	1 piece
B		Leg	4 pieces

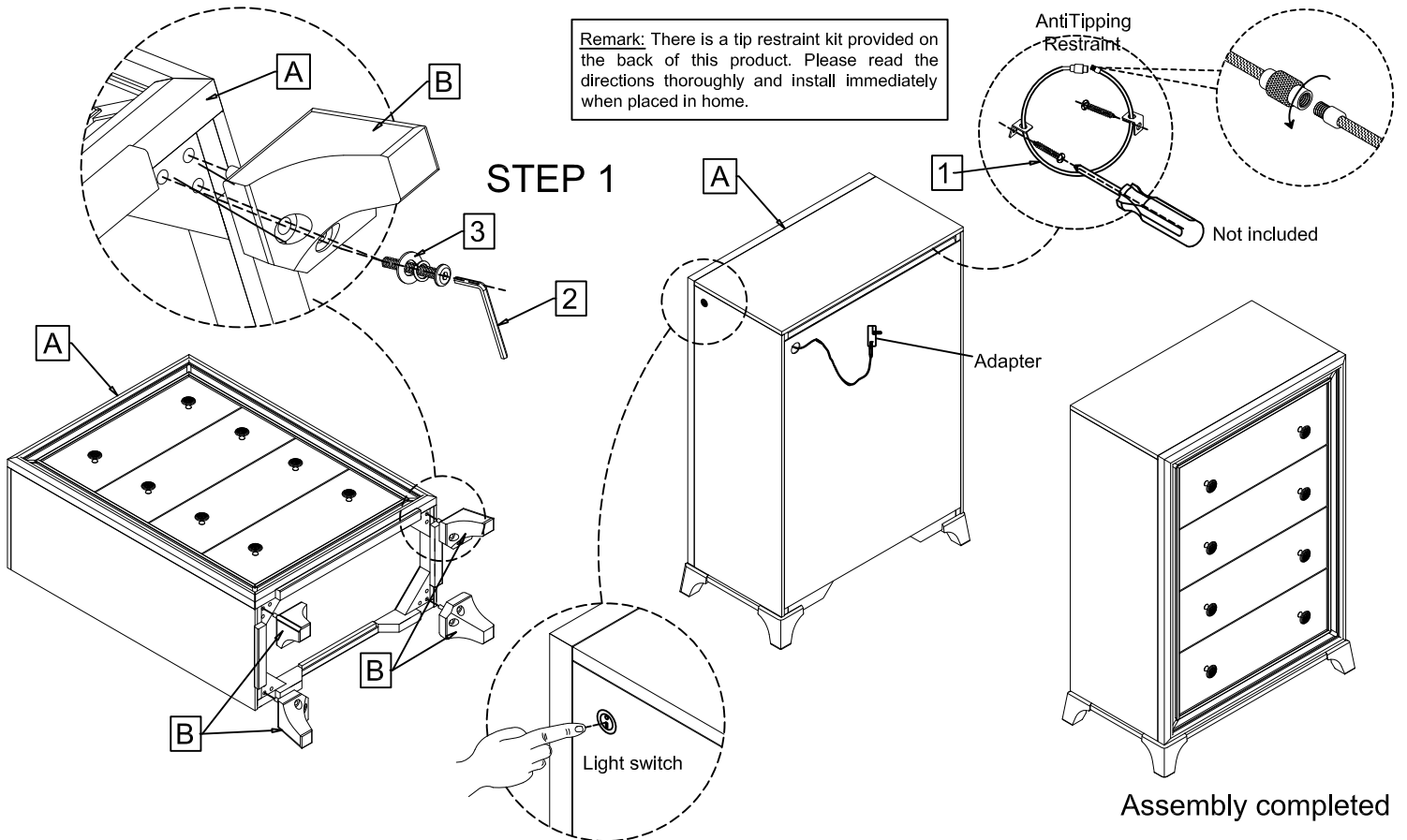





Instructions d'assemblage

Commode verticale 591-130

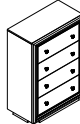
Avertissement : Veuillez lire ces instructions attentivement avant de débiller les pièces pour l'assemblage. Les bouts d'agrafes pointus peuvent provoquer des blessures. Veuillez donc enlever ces agrafes de l'emballage avant de l'ouvrir.

1. Nous vous recommandons de monter ce produit avec l'aide d'une autre personne, ce qui facilitera l'assemblage et évitera d'endommager le produit ou de causer des blessures lors de l'assemblage.
2. Assurez-vous de vérifier tous les matériaux d'emballage avec soin, car les petites pièces ont pu se détacher à l'intérieur du carton pendant le transport.
3. Attendre avant de serrer complètement les vis ou les boulons.
4. Mettre toutes les pièces sur une surface qui ne les abimera pas avant l'assemblage, puis suivre les étapes pour assembler correctement votre nouveau produit.
 - Ne pas laisser les enfants grimper sur les meubles.
 - Ne pas placer de téléviseur sur les commodes, les bureaux ou leurs portes.
 - Placer les objets les plus lourds dans les tiroirs du bas.
 - Ne pas ouvrir plus d'un tiroir à la fois.

NO.:	LISTE DE QUINCAILLERIE (591-130)		QTÉ	NO.:	LISTE DE PIÈCES		
1		ANTI-BASCULEMENT	1 Ens	A		Commode verticale	1 pièce
2		(L57x4MM) CLÉ ALLEN	1 pièce				
3		(Ø5/16*18*2-1/2"L) BOULON	8 pièces	B		Pied	4 pièces
		(Ø5/16*13*1.2MM) RONDELLE D'ARRÉT	8 pièces				
		(Ø5/16*19*1.8MM) RONDELLE PLATE	8 pièces				

